

UDC 620.179:534.6

Sergiy Filonenko<sup>1</sup>  
Tetyana Kositskaia<sup>2</sup>  
Tatiana Nimchenko<sup>3</sup>

## ANALYSIS OF SPEED OF CHANGING ACOUSTIC EMISSION PARAMETERS BY FRICTION OF SURFACES OF COMPOSITE MATERIALS

National Aviation University  
Kosmonavta Komarova avenue 1, 03680, Kyiv, Ukraine  
E-mails: <sup>1</sup>films01@mail.ru; <sup>2</sup>balishap@gmail.com; <sup>3</sup>fiona54@ukr.net

**Abstract.** We analyzed the results of handling of amplitude parameters of model and real resulting signal of acoustic emission by friction of surfaces, made of composite material. It is shown that at the stage of normal wear and tear of the friction assembly, speed of change of amplitude parameters of acoustic radiation stays permanent. Transition of the friction assembly, which precedes the stage of catastrophic wear and tear, brings to rise of speeds of change of amplitude parameters of acoustic emission resulting signal.

**Keywords:** acoustic emission; amplitude; composite; energy; material friction; rotation; signal.

### 1. Introduction

In recent years more and more attention is paid to researching of friction assemblies of composite materials (CM).

Such tendency is determined by the fact that CM have high frictional characteristics and application of them makes service-life of friction assemblies longer.

In spite of high physicochemical characteristics and durability to friction and wear and tear of CM, appearance of the first fracture nucleus of destruction leads to rise of avalanche-like processes which develop during short periods of time.

Stop of friction assembly is almost impossible on such conditions, and therefore prevention of its absolute destruction is impossible as well.

Taking into consideration the specific character of structure and destruction of CM we paid attention to methods of control and diagnosis of friction assemblies made of such materials.

We make complex researches using traditional and non-traditional methods for development of control and diagnosis of friction assemblies made of CM.

However, as experimental practice shows, traditional methods with determination of moment of friction, its coefficient and other characteristics do not have enough sensitivity to microprocesses, which develop on surface layer of CM.

It does not let discover initial stages of appearance of critical processes, and fixation of transition to catastrophic stage does not guarantee prevention of destruction of friction assemblies.

One of the most sensitive methods, which is widely used in researches of friction assemblies made of CM, is method of acoustic emission (AE).

As the results of published researches show, the method of AE has high reaction to change of mechanisms of friction and wear and tear, and lets get significant amount of information about processes.

But interpretation of the registered information (acoustic radiation) produces considerable difficulties and is a problem of use of the AE method for control and diagnosis of friction assemblies made of traditional and CM.

First of all, it is determined by difficulties of experimental researches that are connected with identification of developing processes.

From the other side, significant amount of the analyzed AE characteristics (amplitude and energy, their statistic characteristics) needs determination of their information capability and sensibility to changing processes that develop in surface layer of CM.

From this point of view, theoretical researches, connected with getting of expected regularities of changing of AE characteristics by variation of conditions of friction and wear and tear in friction contact zone, acquire high value.

Such regularities can be a basis in development of methods of control and diagnosis of friction assemblies made of CM.

### 2. Analysis of the latest researches and publications

Researches of processes of friction and wear and tear of surface layers using AE method include wide circle of materials – materials with traditional structure and CM [2, 4, 6, 8, 9, 10].

However, majority of works are of experimental character.

As a rule, results of the received data analysis have descriptive character with comparative rate of sensibility of the registered information to traditional characteristics.

For instance, average level of amplitude of AE registered signal and coefficient of friction.

We can underline not only sensibility of AE method, but also complex character of acoustic radiation with its modification during the whole process of friction and wear and fear.

At the same time, there are almost no data about correlation of parameters of AE with operational characteristics of work of friction assemblies.

Similar patterns are considered in theoretical researches of AE by friction of surface layers of materials with traditional structure and CM [1, 2, 5].

In the following researches we consider formation of acoustic radiation as a result of coherent destruction of the areas of contact interaction.

Assume the destruction of each area of frictional contact to accompany with formation of single AE impulse signal and resulting signal is in the form:

$$U_p(t) = \sum_j U_j(t - t_j), \quad (1)$$

where  $j$  – order number of the area of contact interaction ( $j = 1, 2, 3, \dots, m$ );

$U_j(t_j)$  –  $j$  AE impulse signal, that is formed by destruction of  $j$  area of contact interaction;

$t_j$  – moment of time of appearance of  $j$  AE signal;

$m$  – general number of AE impulse signals, that are formed during the time of work of the friction assembly (in specified length of realization).

Moment of time  $t_j$  of appearance of each AE impulse signal, according to (1), is in the form:

$$t_j = j\Delta t_j \pm \delta, \quad (2)$$

where  $\Delta t_j$  – time lag between beginning of appearance of consequent and preceding AE impulse signals (beginning of destruction of the consequent and preceding area of contact interaction);

$\delta$  – random component at the moment of appearance of every consequent AE signal.

Introduction of the component  $\delta$  in expression (2) is determined by existence of inhomogeneity of materials in the area of contact interaction, instability of position of every consequent platform in the area of overlapping of surface layers of the friction assembly, instability of speed of rotation of friction assembly and influence of other factors.

In the form (1) for AE resulting signal, which is formed during friction and wear and tear on the surface of materials with traditional structure and CM, difference of models is in varieties of AE impulse signals  $U_j(t_j)$ , that appear by destruction of the areas of contact interaction.

Models of AE impulse signals are built accounting specific character of destruction of materials and kinetics of these processes.

By making the model of AE impulse signal, which is formed during destruction of CM by transversal force, we used conception of introduction of CM in form of fiber bundle model [7].

According to the conception, destruction of CM is considered as a process of coherent destruction of it, taking into consideration redistribution of voltage to the remained elements.

Besides, matrix is considered to be flexible or to have less strength than CM elements (bundle).

Destruction of the matrix does not lead to destruction of CM, and destruction of itself is determined by destruction of the bundle. Gradual accumulation of amount of destructed elements leads to absolute destruction of CM. In other words, elements of CM stand basic load and destruction of them leads to destruction of CM.

On such conditions, taking into consideration the “OR” rule (CM elements are destructed at the expense of bending and stretching, when equivalent strain reaches some threshold level) and independent steady distribution of threshold levels of destruction with borders [0, 1], and kinetics of development of the process of elements destruction, AE impulse signal is in the form:

$$U(t) = U_0 \nu_0 [\alpha t (1 - \alpha t) (1 - g\sqrt{\alpha t}) - \alpha t_0 (1 - \alpha t_0) (1 - g\sqrt{\alpha t_0})] \times \\ \times e^{\int_{t_0}^t [\alpha t (1 - \alpha t) (1 - g\sqrt{\alpha t}) - \alpha t_0 (1 - \alpha t_0) (1 - g\sqrt{\alpha t_0})] dt} \quad (3)$$

where  $U_0 = N_0 \beta \delta_S$  – maximum displacement, which appears by instantaneous destruction of all CM elements;

$N_0$  – amount of CM elements before beginning of destruction;

$\beta$  – coefficient of proportionality;

$\delta_S$  – parameter, numerical value of which is determined by the form of single pulse of perturbation during destruction of one CM element;

$\alpha$  – speed of CM elements loading;

$t, t_0$  – respectively, current time and the time of beginning of CM elements destruction;

$g$  – coefficient, which is determined by geometric sizes of CM elements (its length and area of cross-section);

$r, \nu_0$  – coefficients, which depend on physico-technical characteristics of CM.

In work [3], according to (1), (2) and (3), we considered simulation results of amplitude characteristics of AE resulting signal by transition of friction assembly of CM from the phase of normal to the stage of catastrophic wear and tear.

Friction assembly made of CM is a set of surface layers of frictional contact in form of rollers and rings.

One of surface layers moves relative to another.

Area of contact interaction a small platform  $S_T$ , in general area of S overlap of surface layers made of CM. We can see destruction of certain amount of CM elements  $N_0$  during rotation of the friction assembly with the given speed  $\alpha$  within the area  $S_T$ . Elements have definite physico-technical characteristics and sizes ( $\nu_0, r$  and  $g$ ).

According to (3), AE impulse signal is formed by destruction of CM elements.

Change of work conditions of friction assembly (stressedly-deformed state and area of contact interaction) let made modeling of joint AE resulting signal, which is formed during transition from stage to stage of friction.

Results of modeling showed that change of amplitude characteristics of AE resulting signal happen during the process of friction. Increase of amplitude parameters of acoustic radiation must take place at the phase, which precedes the phase of catastrophic wear and tear or at primary stages of origin of catastrophic wear and tear.

As data processing of received materials showed, percentage increase of average amplitude level of AE resulting signal and its dispersion almost coincide with each other.

Their increase advances the increase of standard deviation of average level of amplitude of AE resulting signal.

From the point of view of control and diagnosis of tribosystems made of CM, analysis of rate of change of amplitude parameters by change of work conditions of friction assembly becomes rather interesting.

### 3. Research tasks

We will consider the results of modeling of AE resulting signal, which is formed at all stages of

friction and wear and tear of layers of frictional contact made of CM.

Regularities of speed of changing of amplitude parameters of AE resulting signal will be shown as well.

We will also give information about the fact that during transition from stage of normal wear and tear to the stage before catastrophic wear and tear we can see increase of speed of change of average level of amplitude of AE resulting signal, speed of its standard deviation and dispersion.

### 4. Theoretical results

According to (1), let us use the method of calculation, given in work [10], by modeling of AE resulting signal.

Modeling will be made in relative units.

We will study the stage of stable wear and tear, stage of transition to catastrophic wear and tear, stage of catastrophic wear and tear and stage of steady catastrophic wear and tear.

Separation of these stages is determined by observed experimental regularities of modification of acoustic radiation during friction and wear and tear of layers made of CM.

During modeling, let us take the same initial conditions as in [3].

Value of parameters  $\nu_0, g$  and  $r$ , that (3) includes, in relative values will be:

$$\tilde{\nu}_0 = 10^6; \quad \tilde{g} = 0,1; \quad \tilde{r} = 10^4.$$

At the stage of normal wear and tear values  $\alpha, P$ , and  $S$  (speed of rotation, axial load and area of contact interaction, relatively), in relative values will be:

$$\tilde{\alpha} = 200; \quad \tilde{P} = 1; \quad \tilde{S} = 1.$$

At the stage of transition to catastrophic destruction values will be:

$$\tilde{\alpha} = 200, \dots, 400; \quad \tilde{P} = 1, \dots, 2; \quad \tilde{S} = 1.$$

At the stage of catastrophic destruction values  $\alpha, P$ , and  $S$  will be:

$$\tilde{\alpha} = 400, \dots, 500; \quad \tilde{P} = 2, \dots, 2,5; \quad \tilde{S} = 1, \dots, 1,5.$$

At the stage of catastrophic destruction values  $\alpha, P$ , and  $S$  will be:

$$\tilde{\alpha} = 500; \quad \tilde{P} = 2,5; \quad \tilde{S} = 1,5, \dots, 1,7.$$

Increase of values of  $\alpha$  is determined by increase of  $\tilde{P}$ , that is given in work [2].

By such conditions we will see the change of boundary voltage  $\sigma_0$  of destruction of CM elements, values of which, according to made calculations for

specified time of beginning of destruction  $\tilde{t}_0 = 0,0006$ , are:

- by  $\alpha = 200 - \tilde{\alpha}_0 = 0,10194191$ ;
- by  $\tilde{\alpha} = 400 - \tilde{\alpha}_0 = 0,173464261$ ;
- by  $\tilde{\alpha} = 500 - \tilde{\alpha}_0 = 0,198498$ .

Calculations of boundary voltage of destruction were made using the form:

$$\tilde{\alpha} = \tilde{\alpha}\tilde{t}(1 - \tilde{\alpha}\tilde{t})(1 - \tilde{g}\sqrt{\tilde{\alpha}\tilde{t}}) \quad (4)$$

On conditions that  $t = t_0$ .

Parameters in (4) correspond to the parameters that were considered in form (3).

The result of modeling of AE resulting signal, according to the accepted conditions, that is formed at all stages of friction and wear and tear, in the form of a graph of change of its energy temporally in relative units is shown in Fig. 1.

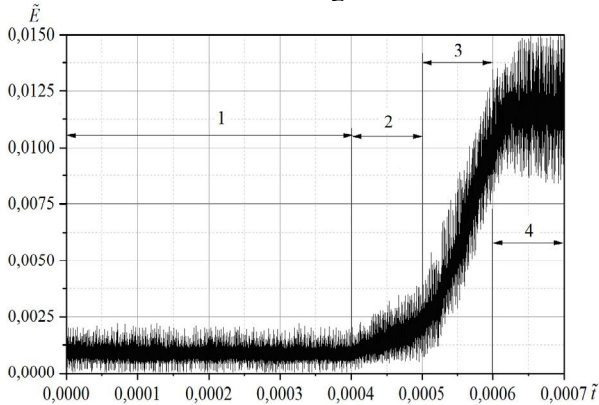

**Fig. 1.** Graph of dependence of change of energy of AE resulting signal during time in relative units by friction of the layer made of CM:

- 1 – stage of normal wear and tear;
- 2 – stage that precedes catastrophic destruction of layers;
- 3 – stage of catastrophic destruction of surface layers;
- 4 – stage of stable catastrophic destruction

Having looked at Fig. 1 it can be seen that by coherent development of processes of destruction of surface layers of CM and transition from one stage to another, no changes in character of acoustic radiation can be noticed.

But transitions are accompanied with change of parameters of AE resulting signal.

Such change of parameters of AE resulting signal is confirmed by statistic proceeding of data by steady layout of lengths of realization of each detailed stage to samplings, length of which is 250 rated points of amplitude of AE resulting signal.

However, increase of average level of amplitude of AE resulting signal, its standard deviation and

dispersion during transition to every consequent stage happens in different ways.

It can be perfectly seen at dependencies of speed of analyzed parameters change, which are shown in Fig. 2 for stage of normal wear and tear, the stage that precedes the stage of catastrophic wear and tear, the stage of catastrophic wear and tear and the stage of stable catastrophic wear and tear (Fig. 1, stages 1, 2, 3, 4).

In Fig. 2 we presented graphs in normalized rates of change of speed of each analyzed parameter – normalized speeds of change of average level of amplitude, its standard deviation and dispersion for AE resulting signal.

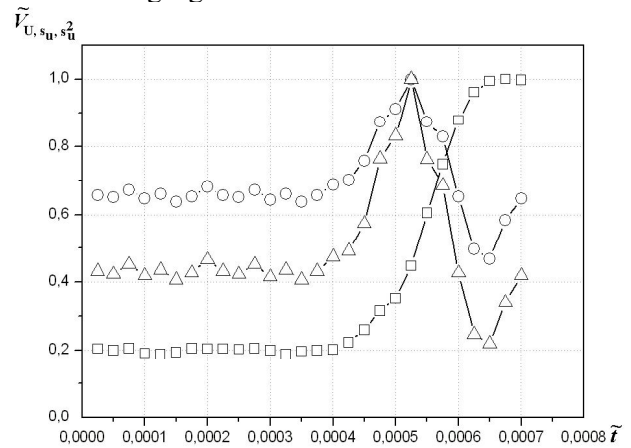

**Fig. 2.** Graphs of speed of change of the amplitude parameters of AE resulting signal (Fig. 1) at temporally stages 1, 2, 3, 4 in normalized units:

- – speed of change of average level of amplitude  $\tilde{V}_{\bar{U}}$ ;
- – speed of change of standard deviation of average level of amplitude  $\tilde{V}_{S_{\bar{U}}}$ ;
- △ – speed of change of dispersion of average level of amplitude  $\tilde{V}_{S_{\bar{U}}^2}$

But at the preceding catastrophic wear and tear stage (stage 2 in Fig. 1, with  $\tilde{t}$  in the range of values from 0,0004 to 0,0005) it can be seen that permanent rise of speed of amplitude parameters of AE resulting signal (Fig. 2).

At the stage of catastrophic wear and tear (stage 3 in Fig. 1 with  $\tilde{t}$  in the range of values from 0,0005 to 0,0006) permanent rise of speed of change of average rate of AE resulting signal (Fig. 2) can be noticed.

At the same time speeds of change of standard amplitude level and its dispersion rise at first, and then we can see their fall.

In what follows at the stage of permanent catastrophic wear and tear we can see gradual rise of speed of change of the given parameters (Fig. 1,

stage 4  $\tilde{t}$  in the range of values from 0,0006 to 0,0007) (Fig. 2).

From the point of view of control and diagnosis of tribosystems, made of CM, for prevention of their destruction, it is interesting to analyze of speed of change of amplitude parameters of acoustic radiation at the stage, which precedes the stage of catastrophic wear and fear.

It is determined by need of their sensitivity and reaction determination as to appearance of elementary stages of origin of processes, which lead to development of transition of the friction assembly to the stage of catastrophic wear and tear.

In Fig. 3 you can see dependence of speed of change of amplitude parameters of AE resulting signal for stages 1 and 2, according to Fig. 1.

Graphic in Fig. 3 is given in normalized values of change of speeds of amplitude parameters of AE resulting signal.

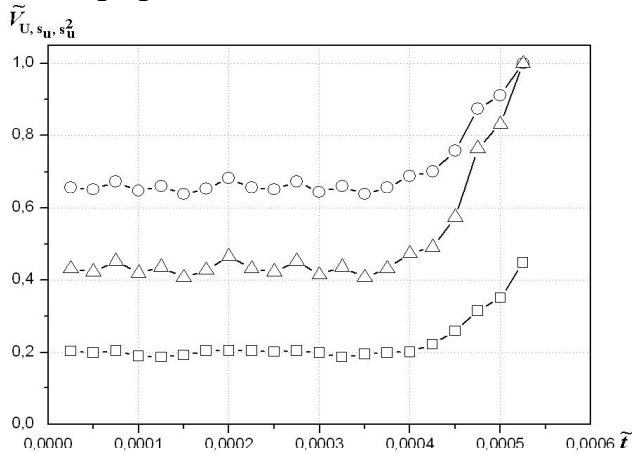

**Fig. 3.** Graphs of speed of change of amplitude parameters of AE resulting signal (Fig. 1) at the stages 1, 2 and elementary phase of the stage 3 in time in normalized units:

- – speed of change of average level of amplitude  $\tilde{V}_{\bar{u}}$ ;
- – speed of change of standard deviation of average level of amplitude  $\tilde{V}_{S_{\bar{u}}}$ ;
- △ – speed of change of dispersion of average level of amplitude  $\tilde{V}_{S_{\bar{u}}^2}$

Normalizing of AE parameters in Fig. 3 corresponds to normalizing of their values according to Fig. 2.

Having looked at Fig. 3 it can be seen that at the stage of normal wear and tear of speed of change of average level of the amplitude, its standard deviation and dispersion stay absolutely permanent for AE resulting signal.

However, during transition of the friction assembly, made of CM, which precedes the stage of catastrophic wear and tear, that is stage 2 in Fig. 1, we can see rise of speed of change of all analyzed parameters.

At the same time rise of speeds of change of average level of amplitude and its dispersion are similar (Fig. 3) and lag behind the rise of speed of change of standard deviation of the average level of amplitude of AE resulting signal.

Let us make processing of the received data with definition of speed of increase of amplitude parameters of AE resulting signal according to their values, which correspond to the moment of time of transition to the stage that precede the stage of catastrophic destruction, that is according to the moment of time  $\tilde{t} = 0,0004$ .

Results of the made researches showed that with  $\tilde{t} = 0,000475$  speed of change of average level of amplitude of AE resulting signal, its dispersion and standard deviation increase in 1,56 times, in 1,6 times and in 1,3 times, respectively. And with  $\tilde{t} = 0,0005$  their increase is in 1,74 times, in 1,75 times and in 1,32 times.

With  $\tilde{t} = 0,000525$  rise of speed of analyzed parameters is: in 2,22 times, in 2,1 times and in 1,45 times, respectively.

Having analyzed the received data in accordance with the results of the made modeling, it can be seen that during transition of the friction assembly from the stage of normal to the stage, which precedes the one of catastrophic destruction, we can observe rise of speeds of change of amplitude parameters of AE resulting signal.

Results of the made researches also show that development of processes of destruction of surface layers, made of CM, during friction with transition to the stage of catastrophic wear and tear leads to further increase of amplitude parameters of acoustic radiation.

### 5. Experimental results

We made samples in the form of bushing, made of steel 30XGCA and aluminum alloy D16 with carbide surface layer VK6 (Fig. 4, a), for making researches of AE during friction of layers, made of CM. Sizes of the samples were: outer diameter 28 mm; inner diameter 20 mm; height 22 mm.

Test of the samples was made with use of the constructive scheme “disk-disk”.

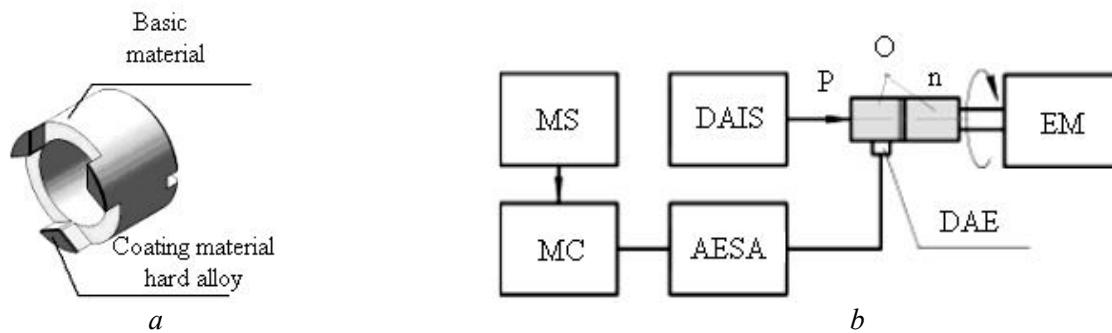

**Fig. 4.** Sample with carbide cover for making tests to define wear and tear according to constructive scheme “disk-disk” (a) and scheme of test bench (b):

EM – electric motor of the machine CMT-1; O – samples for testing; P – axial load

Contact interaction of the samples was made on frontal surface layers with carbide cover.

Tests were made on testing machine CMT-1 with the help of computer control of its work modes Fig. 4, b.

For the scheme, we used, one of the samples was fixed and the other one rotated in the spindle of the testing machine.

Size of the area of contact interaction of the samples was given with use of slits on the frontal layers of the samples (Fig. 4, a).

Depth of slits was 5 mm and they were steadily placed on the frontal layer of the samples.

On such conditions the layer of contact interaction was characterized with the help of the coefficient of overlap  $K_S$ , which shows connection of the whole area of the frontal layer with contacting area of the frontal layer.

During the tests value of the coefficient  $K_S$  was  $K_S = 0,25$ . Rotation speed of the driving shaft of the friction machine CMT-1 was 500 rpm.

Axial load intensity to a pair of friction was given with the help of Device for Axial Load Set (DALS) (Fig. 4, b) and was 450 H.

Oil M10G2K was used for lubricating environment. Oil consumption was 1,2 l ph.

For researching of AE signals we used Acoustic-emissive Diagnostic Complex (AEDC).

It consists of AE Detector (DAE), AE Signal Amplifier (AESA), and Mobile Computer (MC) with Mathematical Software (MS) (Fig. 4, b). AE detector was set on the fixed sample (Fig. 4, b). DAE was made of piezoelectric ceramics ZTC-19. By setting of the detector, its surface was lubricated with acousto-transparent lubricant. AE registered signals were coming from exit of the detector to AESA, and then to MC (Fig. 4, b).

Handling of AE signals, using MS, was made in MC (Fig. 4, b).

According to the results of handling of parameters of AE registered signals we formed data, which were kept in form of logical bodies.

The results of handling were shown at the monitor screen in form of graphic curves (AESA in time), they also were transformed in sizes for mathematical software for Windows.

This software was used for making static handling of parameters of registered AE signals.

During tests, AE signal was registered at all stages of friction and wear and tear of the samples, including the stage of catastrophic wear and tear. Dependence of change of amplitude of the registered resulting signal is shown in Fig. 5.

Having looked at Fig. 5 it can be seen that AE resulting signal is permanent for given test conditions at all stages of wear and tear.

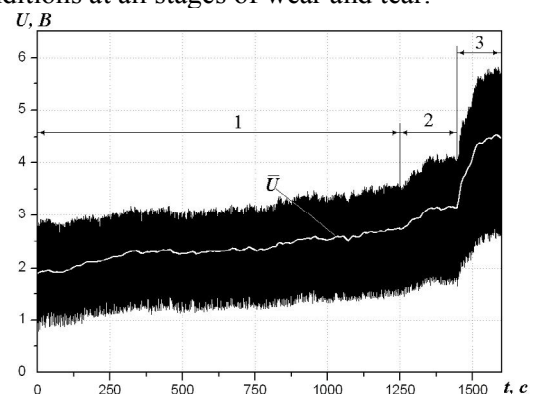

**Fig. 5.** Graph of dependence of change of amplitude of AE resulting signal in time in relative units during friction of samples surface layers with BK6 cover:

- 1 – stage of normal wear and tear;
- 2 – stage, which precedes catastrophic destruction of surfaces;
- 3 – stage of catastrophic wear and tear (destruction) of the surface layers

$\bar{U}$  – average level of amplitude of AE resulting signal, respectively

Such AE signal can be characterized by average level of amplitude and value of its dispersion.

At the stage of normal wear and tear of the samples (Fig. 5, stage 1) we can see gradual increase of average level of amplitude ( $\bar{U}$ ) of AE resulting signal.

By making the curve  $\bar{U}$  (Fig. 5), averaging time of amplitude of AE resulting signal was 15 s.

Increase of average level of AE amplitude can be observed at stages 2 and 3 (Fig. 5) as well.

However, its increase is higher than at stage 1.

At the same time there is a peculiarity in character of change of acoustic radiation during transition to stages 2 and 3.

We can observe the increase of not only average level of amplitude parameters of AE resulting signal but also values of their dispersion.

Results of statistic of treatment of AE parameters at all analyzed stages in the form of a graph of change speed of average level of amplitude of AE resulting signal, and also change speed of its standard deviation and dispersion in time are shown in Fig. 6.

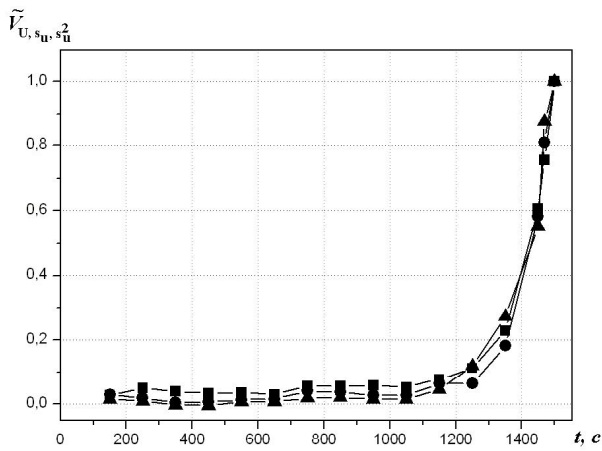

**Fig. 6.** Graphs of speed of change of amplitude parameters of AE resulting signal (Fig.4) at stages 1, 2 and primary phase of stage 3 in time in normalized units during friction of the samples with BK6 cover:

- – speed of change of average level of amplitude  $\tilde{V}_{\bar{U}}$ ;
- – speed of change of standard deviation of average level of amplitude  $\tilde{V}_{s_{\bar{U}}}$ ;
- ▲ – speed of change of dispersion of average level of amplitude  $\tilde{V}_{s_{\bar{U}}^2}$

Graphs in Fig. 6 are given in normalized units.

By making the graphs (Fig. 6) length of the sampling for statistic analysis of the data with definition of change speed of average level of

amplitude of AE resulting signal, and also change speed of its standard deviation and dispersion at stage 1 (Fig. 5) was 100 s.

At stages 2 and 3 (Fig. 5) length of sampling was 50 s.

Quantity of observed points was 10 000 and 5000, respectively.

Having looked at Fig. 6 it can be seen that at the stage of stable wear and tear (stage 1) speed of change of amplitude parameters of AE resulting signal are almost permanent.

During transition to stage 2, that is the stage, which precedes the stage of catastrophic wear and tear, we can observe rise of speed of change of all analyzed AE parameters.

Then we see rise of speed of change of AE amplitude parameters.

But rise of speed of change of dispersion of average level of amplitude of AE resulting signal advances both: rise of speeds of change of average level of amplitude and speed of change of its standard deviation (Fig. 6).

During transition to stage 3, rise of speed of change of dispersion of average level of amplitude of AE resulting signal becomes slower to other analyzed parameters.

Such changes of parameters of AE resulting signal can be seen at dependencies of percentage increase of amplitude parameters of AE resulting signal in time (Fig. 7).

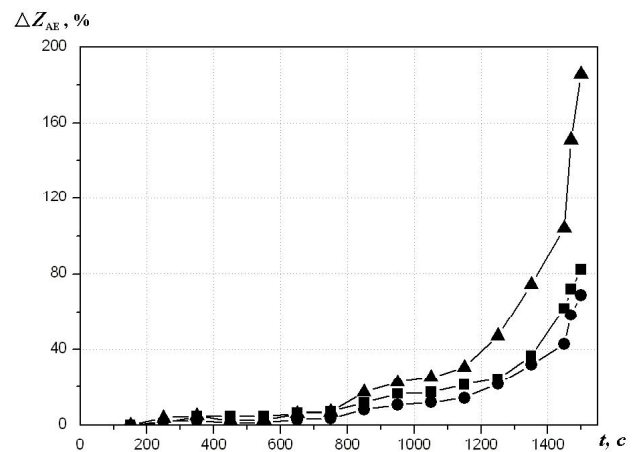

**Fig. 7.** Graph of percentage increase of amplitude parameters of AE resulting signal (Fig. 5) at stages 1, 2 and at the primary phase of the stage 3 in time during friction of the samples with BK6 cover:

- – percentage increase of average level of amplitude ( $\bar{U}$ ), its standard deviation;
- – ( $s_{\bar{U}}$ ) and dyspercia;
- ▲ – ( $s_{\bar{U}}^2$ )

Having looked at Fig. 6 it can be seen that during friction and wear and tear of the samples with BK6 cover we can observe increase of amplitude parameters of AE resulting signals.

Big percentage increase of analyzed parameters happens together with transition to the stage, which precedes the stage of catastrophic wear and tear (Fig. 5, stage 2).

At the same time percentage increase of average level of amplitude of AE resulting signal advances both: percentage increase of average level of amplitude and percentage increase of its standard deviation.

## 6. Conclusions

Statistical analysis of parameters of AE resulting signal showed that speeds of change of average rate of the amplitude, its standard deviation and dispersion at the stage of normal wear and tear are permanent.

During transition to the stage, which precedes the stage of catastrophic wear and tear, we can see rise of speed of increase amplitude parameters of acoustic radiation.

From the point of view of control and diagnosis of friction assemblies, made of CM, this stage is the most interesting.

We made experimental researches of AE during friction of surface layers, made of CM.

All the received results showed rather good compliance with the results of theoretic researches.

It was determined that speed of change of AE amplitude parameters stays almost permanent at the stage of normal wear and tear of the friction assembly.

However, transition of the friction assembly to the stage, which precedes the stage of catastrophic wear and tear, brings to increase of speed of rise of parameters of acoustic radiation.

At the same time we can admit that research of speed of change of energy characteristics of acoustic radiation during transition of the friction assembly from the stage of normal to the stage of catastrophic wear and tear.

## References

- [1] *Filonenko, S.F.; Kosmach, O.P.* Influence of friction surfaces properties of composite materials on acoustic emission. Proceedings of the National Aviation University. 2013. N1. P. 70–77.
- [2] *Filonenko, S. F.; Kosmach, O.P.* Patterns of change in acoustic emission with increasing load on the friction pair of composite material. Proceedings of the National Aviation University. 2013. N 2. P. 79–89 (in Ukrainian).
- [3] *Filonenko, S.F.; Kosmach, O.P.* Simulation of acoustic emission signals in friction and wear surfaces of composite materials. Proceedings of the CSTU. 2013. N 3. P. 88–96.
- [4] *Filonenko, S.F.; Stadnychenko, V.M.; Stahova, A.P.* Modelling of acoustic emission signals at friction of materials' surface layers. Aviation. 2008. Vol. 12, N 3. P. 87–94.
- [5] *Filonenko, S.F.; Stakhova, A.P.; Kositskaya, T.N.* Modeling of the acoustic emission signals for the case of material's surface layers distraction in the process of friction. Proceedings of the National Aviation University. 2008. N 2. P. 24–28.
- [6] *Hase, A.; Wada, M.; Mishina, H.* Acoustic emission in elementary processes of friction and wear: In-situ observation of friction surface and AT signals. J. of advanced mechanical desing, items and manufacturing. 2009. Vol. 3. N 4. P. 333–344.
- [7] *Kun, F.; Zapperi, S.; Herrmann, H. J.* Damage in fiber bundle models. Eur. Phys. J. B. 2000. Vol. 17, N 2. P. 269–279.
- [8] *Liao, C.; Suo, S.; Wang, Y.; Huang, W.; Liu, Y.* Study on stick-slip friction of reciprocating o-ring seals using acoustic emission techniques. Tribology transactions. 2012. Vol. 55, N 1. P. 43–51.
- [9] *Mechefske, C.K.; Sun, G.; Sheasby, J.* Using acoustic emission to monitor sliding wear. Insight. 2002. Vol. 44, N 8. P. 1–8.
- [10] *Rubtsov, V.E.; Kolubaev, A.V.; Popov, V.L.* The use of acoustic emission analysis for the wear in sliding friction. Letters to ZHTF. 2013. Vol. 4. P. 79–86.

Received 4 April 2014.



**С.Ф. Філоненко<sup>1</sup>, Т.М. Косицька<sup>2</sup>, Т.В. Німченко<sup>3</sup>. Аналіз швидкості зміни параметрів акустичної емісії при терті поверхонь із композиційних матеріалів**

Національний авіаційний університет, просп. Космонавта Комарова, 1, Київ, Україна, 03680

E-mails: <sup>1</sup>films01@mail.ru; <sup>2</sup>balishap@gmail.com; <sup>3</sup>fiona54@ukr.net

Розглянуто результати обробки амплітудних параметрів модельного результуючого сигналу акустичної емісії при терті поверхонь із композиційних матеріалів. Показано, що на стадії нормального зношування вузла тертя швидкість зміни амплітудних параметрів акустичного випромінювання не змінюється. Показано, що при переході вузла тертя до різних стадій зношування відбувається зростання швидкостей зміни амплітудних параметрів результуючого сигналу акустичної емісії.

**Ключові слова:** акустична емісія; амплітуда; енергія; композиційний матеріал; обертання; сигнал; тертя.

**С.Ф. Филоненко<sup>1</sup>, Т.Н. Косицкая<sup>2</sup>, Т.В. Нимченко<sup>3</sup>. Анализ скорости изменения параметров акустической эмиссии при трении поверхностей из композиционных материалов**

Национальный авиационный университет, просп. Космонавта Комарова, 1, Киев, Украина, 03680

E-mails: <sup>1</sup>films01@mail.ru; <sup>2</sup>balishap@gmail.com; <sup>3</sup>fiona54@ukr.net

Рассмотрены результаты обработки амплитудных параметров модельного и реального результирующего сигнала акустической эмиссии при трении поверхностей из композиционных материалов. Показано, что на стадии нормального износа узла трения скорость изменения амплитудных параметров акустического излучения остается неизменной. Показано, что при переходе узла трения на стадию, предшествующую стадии катастрофического износа, возрастают скорости изменения амплитудных параметров результирующего сигнала акустической эмиссии.

**Ключевые слова:** акустическая эмиссия; амплитуда; вращение; композиционный материал; сигнал; трение; энергия.

**Filonenko Sergiy.** Doctor of Engineering. Professor.

Director of the Institute of Information-Diagnostic Systems, National Aviation University, Kyiv, Ukraine.

Education: Kyiv Polytechnic Institute, Kyiv, Ukraine (1977).

Research area: diagnostics of technological processes and objects, automatic diagnostic systems.

Publication: 250.

E-mail: films01@mail.ru

**Kositskaya Tetyana.** Candidate of Chemical Science.

National Aviation University, Kyiv, Ukraine.

Education: Kyiv Polytechnic Institute, Kyiv, Ukraine (1982).

Research area: physical-chemical processes in the materials and their diagnostic.

Publication: 40.

E-mail: balishap@gmail.com

**Nimchenko Tatiana.** Candidate of Engineering. Associate Professor.

Department of Information Security Tools, National Aviation University, Kyiv, Ukraine.

Education: National Aviation University, Kyiv, Ukraine (2005).

Research area: diagnostics of technological processes, signal processing.

Publication: 80.

E-mail: fiona54@ukr.net