

UDC 519.7:519.85 (045)

DOI: 10.18372/1990-5548.57.13251

¹B. Ya. Blagitko,
²Yu. S. Mochulsky

ENSURING THE SAFE LANDING OF THE QUADROPTER IN AN ACCIDENT

^{1,2}Department of Radiophysics and Computer Technologies, Ivan Franko Lviv's National University,
Lviv, Ukraine

E-mails: ¹blagitko@gmail.com, ²mochulsky@ukr.net

Abstract—By means of mathematical modeling, the main features of emergency landing of quadcopter are determined. The results of simulate landings of the quadcopter in cases of failure of one of four pairs of electric motor screw are given. The methods of safe landing of an unmanned quadcopter in case of failure of one of four pairs of motor-screw are proposed. The basis of the proposed methods is to use a parachuting effect. Parachuting achieved by forced off the power of the motor, which is located at the opposite end of the same yoke as faulty motor. As a result, the vertical speed of the quadcopter at the time of landing significantly decreases in comparison with the speed of free fall.

Index Terms—Quadcopter; altimeter; 3-axis gyroscope; 3-axis accelerometer; 3-axis magnetometer; control.

I. INTRODUCTION

In most articles on the problems of the quadcopter flight it is implicitly assumed that all four pairs of motor-screw and their control circuit are serviceable [1] – [5]. In practice, often there are those or other faults in the sequence of links: the control circuit – the motor-screw. When a malfunction suddenly appears during the quadcopter flight, then an emergency situation occurs.

In this article through mathematical modeling the basic features of quadcopter emergency landings are considered. The results of mathematical modeling of quadcopter emergency landings after the appearance of failure of one of the four electric motor-screws are presented.

II. SIMULATION OF THE QUADROPTER LANDINGS IN THE EVENT OF THE FAILURE OF ONE OF THE FOUR ELECTRIC MOTOR-SCREW

The mathematical model of a quadcopter in flight in the event that all four pairs of electric motor screw and the control scheme of them are regular are considered as two essentially different mathematical models. Actually mathematical model of the quadcopter is the unmanned aerial vehicle (UAV) the inputs of which are the values of the voltage supply of electric motors, and the outputs are the altitude and angles of the roll, pitch and yaw. The mathematical model of the PD regulator is a system in which inputs a measured value from the sensors of height, the angles of the pitch, the roll and the yaw, and the microcontroller implements the PD algorithm and outputs the voltage values of the electric motors. The mathematical model of the quadcopter in flight in the event that all four pairs of electric motor screw and the control scheme are useful, is described by the

system of differential equations of the 16th order in the form of Cauchy [5].

In case of failure of one of the four pairs of electro-motor-screw quadcopter the following cases are possible: failure of the nasal steam motor-screw; failure of the tail-pair motor-screw; failure of the right pair of electric motor-screw; failure of the left pair motor-screw. The simulating of malfunctioning was performed by switching off the power of the faulty motor.

In order to solve the differential equations of the mathematical model of the quadcopter, the implicit Runge–Kutta method TR–BDF2 was used (in the first stage of the equation integrate by the trapezium formula method, and in the second stage of the second order (differentiation formula back is used).

The landing of the quadcopter occurs after it has been suspended at a height of 50 m above the point with coordinates $X = 0$, $Y = 0$. The quadcopter "nose" leads in the direction plus by axis X . In this case, the initial values of the angles of the pitch and the roll are zero, and the angle of yaw is 90° . Simulating the failure of a specific pair of electric motor screw is carried out by assigning the supply voltage of the corresponding motor to a value of 0.0 V for all moments of time $t \Rightarrow ta$, where ta is the moment of failure of a specific pair of the electric motor-screw of the quadcopter.

In all articles [1] – [5] of the simulations the quadcopter motions are considered as movements of the material point of a mass m . But the quadcopter has a complex spatial structure with certain dimensions. In order to see not only the movement of the center of the masses of the quadcopter, but also the idea of its rotation during an emergency landing, the movements of the two points of the quadcopter, the center of mass and the nasal engine, were simulated. On Figure 1 and on Fig.

4 the dashed line shows the trajectory of the center of the masses of the quadcopter, and the squares of the trajectory of the movement of the nasal engine.

The results of mathematical modeling of the process of landing a quadcopter in the event of a failure of one of the four pairs of the electric motor-screw of the quadcopter are given in the form of a graph of trajectories of motion in Fig. 1. Trajectory 1 reflects the process of landing a quadcopter in the failure of the nose pair of electric motor screw, and trajectory 3 – in the event of failure of the tail pair the motor-screw.

Phase portraits of the angles of the Pitch, of the Yaw and of the Roll after having at the time $t_a = 1$ s rejected the nasal engine, give to Fig. 2.

As can be seen from Fig. 2, after the accidental disconnection of the nasal electric motor, the pitch angle begins to decrease (the quadcopter "lowers" the nose). As shown in [3], the nasal and tail motors create the momentum of the forces that the quadcopter rotates in relation to the vertical axis clockwise (if viewed from the bottom). The right and left motors rotate the quadcopter counter-clockwise relative to this axis. Therefore, when the nasal engine fails, the quadcopter starts to rotate counter-clockwise. The Pitch and Yaw create a gyroscopic moment of forces, which begins to rotate the quadcopter relative to the longitudinal axis, that is, there is a roll. Having made a little more than one turn relative to the transverse axis, the quadcopter starts to rotate in the opposite direction, and in the future the Pitch ranges in the vicinity of -150° . As for the longitudinal axis, the quadcopter makes almost five turns in the negative direction and falls to the ground by the right engine.

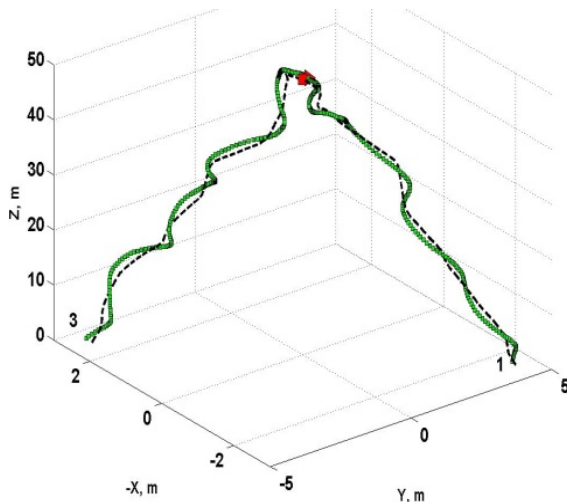

Fig. 1. Trajectories of the motion of the quadcopter with the regulator: 1 – in case of failure of the nose pair motor-screw; 3 – in case of failure of the tail motor-screw

Phase portraits of the angles of the Pitch, of the Yaw and of the Roll after having at the moment $t_a = 1$ s rejected the tail engine, drawn on Fig. 3.

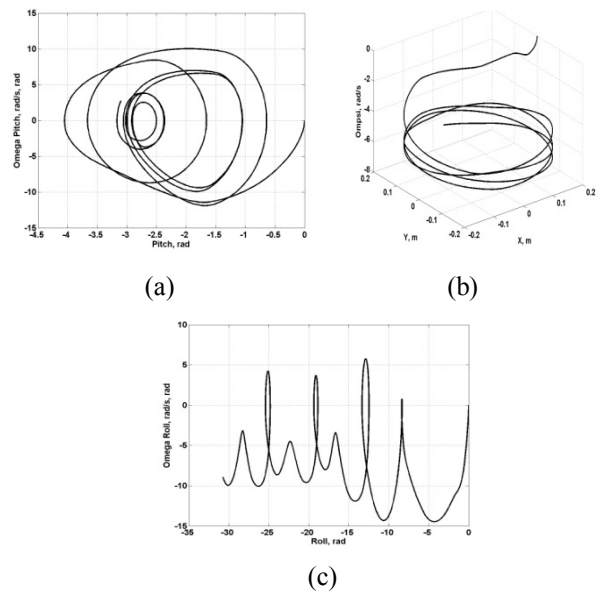

Fig. 2. Phase portraits of pitch, yaw and roll angles when the nose engine fails: (a) is a Pitch; (b) is a Yaw; (c) is a Roll

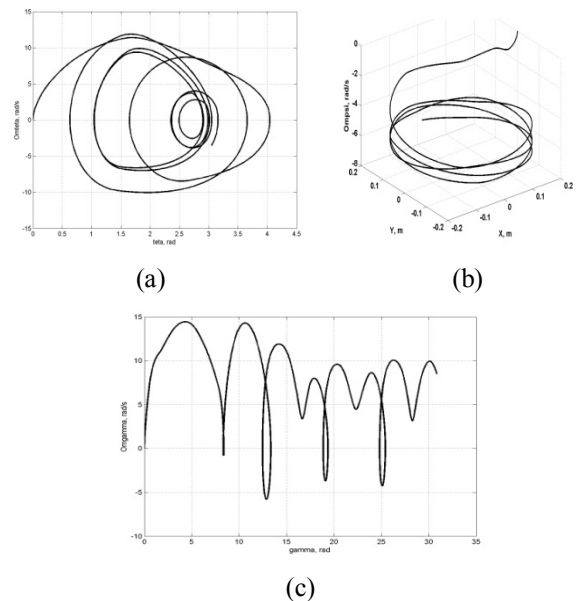

Fig. 3. Phase portraits of pitch, yaw and roll angles when the tail engine fails: (a) is a Pitch; (b) is a Yaw; (c) is a Roll

As can be seen from Fig. 3, after the emergency shutdown of the tail motor, the pitch angle begins to increase (quadcopter "lowers" the tail). As indicated above, the nasal and tail motors rotate the quadcopter relative to the vertical axis in the same direction. But the angular Pitch speed changed the direction of rotation to the opposite. Therefore, the gyroscopic moment of forces causes the quadcopter's Roll in the opposite direction. By making more than one turn in a positive direction relative to the transverse axis, the quadcopter starts to rotate in the opposite direction, and in the future the pitch fluctuates in the vicinity of $+150^\circ$.

With regard to the longitudinal axis, the quadcopter makes almost five turns in a positive direction and falls to the ground on the left engine.

The results of mathematical modeling of the process of landing of the quadcopter in the event of failure of one of the other pairs of the electric motor-screw quadcopter are given in the form of a graph of trajectories of motion in Fig. 4. Trajectory 2 reflects the process of landing the quadcopter with the failure of the right pair motor-screw, and trajectory 4 – in the case of failure of the left pair motor-screw.

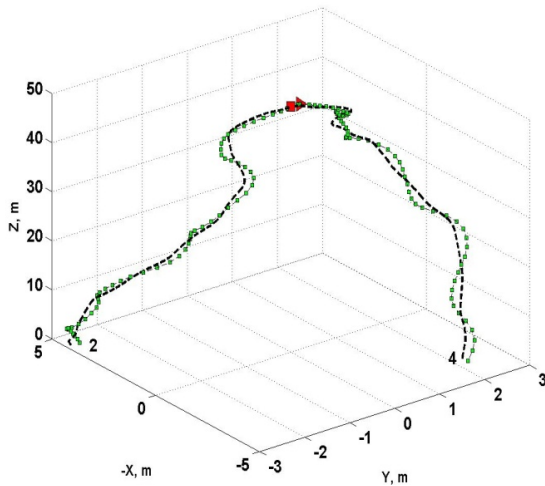

Fig.4. Trajectories of the motion of the quadcopter with the regulator: 2 – in case of failure of the right pair of electric motor-screw; 4 – in the failure of the left pair motor-screw

Phase portraits of the angles of the Roll, of the Yaw and of the Pitch after having at the moment $ta = 1s$ rejected the right engine are shown in Fig. 5.

As can be seen from Fig. 5, after the trip of the right electric motor, the angle of the roll begins to increase (the quadcopter "drops" to the right). The right and left engines create moment of forces, which rotates the quadcopter relative to the vertical axis counterclockwise (if you look from below). Therefore, when the right engine fails, the quadcopter starts to rotate clockwise. The Roll and Yaw create a gyroscopic moment of forces, which begins to rotate the quadcopter relative to the transverse axis, that is, there is a pitch. Having made a little more than one turn relative to the longitudinal axis, the quadcopter begins to rotate in the opposite direction, and in the future the roll varies in the vicinity of $+ 150^\circ$. As for the transverse axis, the quadcopter makes almost five turns in a positive direction and falls to the ground on the nasal motor.

Phase portraits for changing the angles of the roll, yaw and pitch after having turned off the left engine at the time $ta = 1 s$, are shown in Fig. 6.

As can be seen from Fig. 6, after the emergency cut-off of the left electric motor, the angle of the roll begins to decrease (the quad-compressor "falls" to

the left). At the same time, as a result of uncompensated moments of forces relative to the vertical axis, the quadcopter starts to rotate clockwise. The gyroscopic moment of forces causes the quadcopter Pitch. Having made a little more than one rotation relative to the longitudinal axis, the quadcopter starts to rotate in the opposite direction, and in the future the roll varies in the vicinity of -150° . As for the transverse axis, the quadcopter makes almost five turns in the negative direction and falls to the ground on the tail engine

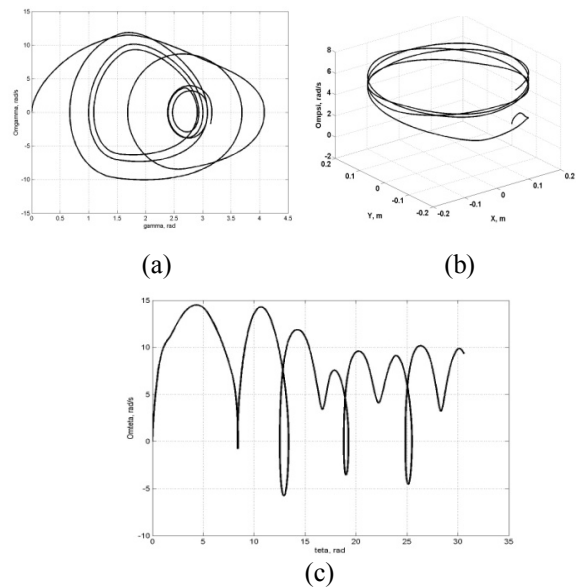

Fig.5. Phase portraits of roll, yaw and pitch angles when the right engine fails: (a) is a Roll; (b) is a Yaw; (c) is a Pitch

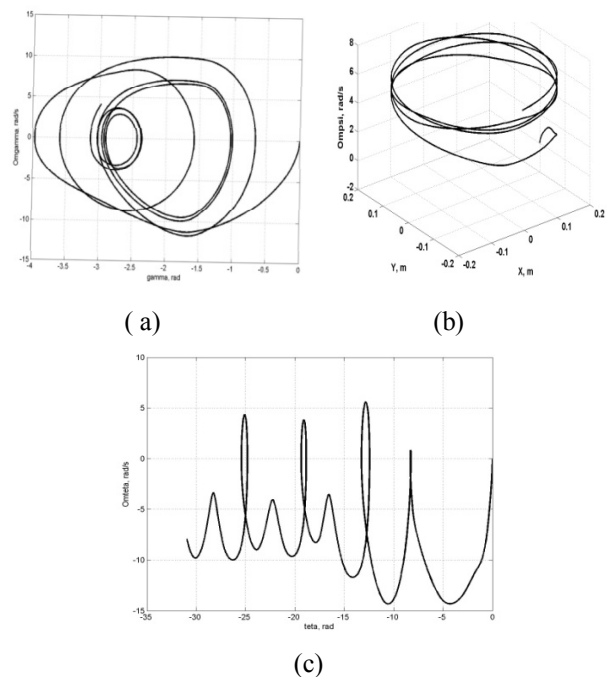

Fig.6. Phase portraits of roll, yaw and pitch angles when the left engine fails: (a) is a Roll; (b) is a Yaw; (c) is a Pitch

It should be noted that the above-mentioned fall of the quadcopter to the ground, when one of the engines fails, is valid only when a drop from a height of 50 m and zero initial angles of pitch and roll. Under other initial conditions, due to the rotation of the quadcopter relative to all three axes, it is possible to fall to the ground in any position.

Emergency landing of a quadcopter with failure of one of four pairs of electric motor-screw has significant disadvantages, namely: unpredictable landing point, unpredicted speed at the time of landing, unpredicted duration of fall and its nature, unpredicted landing angle, and the like.

III. METHOD OF SAFE LANDING OF QUADROPTER WITH FAILURE OF ONE OF THE PAIRS OF ELECTRIC MOTOR-SCREW

This article proposes a control method for the safe landing of a quadcopter with a failure of one of the four pairs of electric motor-screw.

The proposed method is to forcibly shut off the

electric motor, which in pairing with the already defective electric motor is located on the opposite end of the same console. This method uses the parachuting effect of the quadcopter. Parachuting achieved by forced off the power of the motor, which is located at the opposite end of the same yoke as faulty motor. As a result, the vertical speed of the quadcopter at the time of landing significantly decreases in comparison with the speed of free fall.

For example, the simulation results of a safe landing of an emergency quadcopter with a height of 50 m over a point with coordinates $X = 0, Y = 0$. Quadcopter at the same time "hangs" motionless (the angles of the pitch and the roll are zero). The main parameters of the quadcopter: mass – 468 g, distance from the center of mass to the engine – 22.5 cm, EMC battery – 11.1 V.

Phase portraits of the angle of Yaw for the proposed method of safe emergency landing of the quadcopter are shown in Fig. 7.

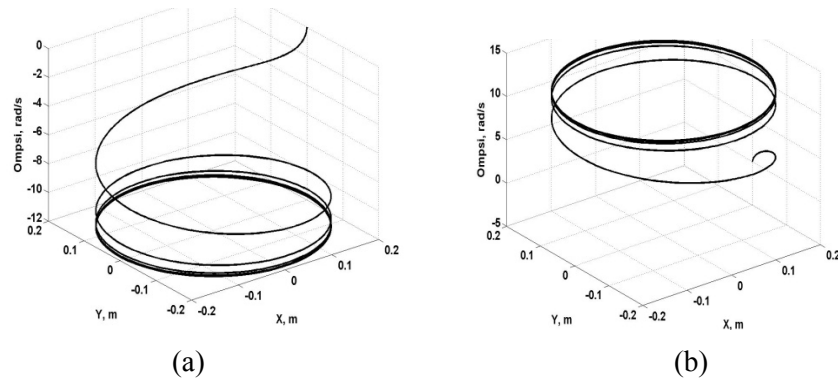

Fig.7. Phase portraits of the angle of Yaw in the failure (a) of the nose or tail engine and (b) of the right or left engine

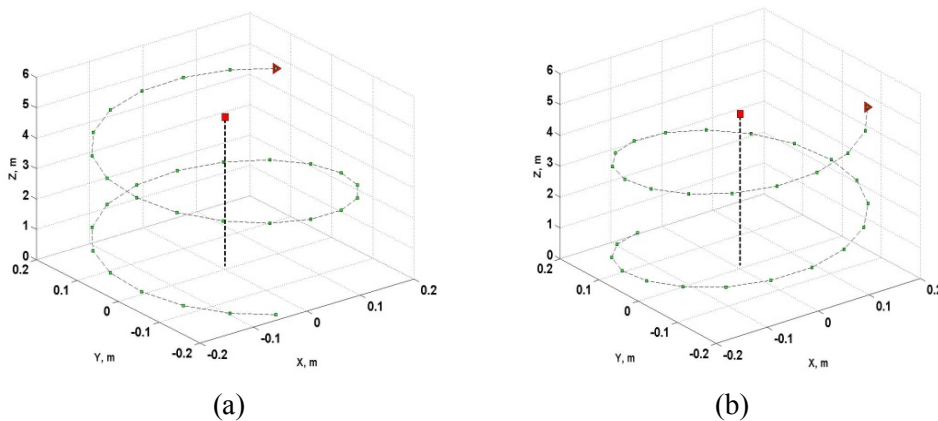

Fig.8. Safe landing of the quadcopter with the failure (a) of the nose or tail engine and (b) of the left or right engine

Figure 8a depicts a fragment of a safe emergency landing of a quadcopter with a failure of the nasal engine and the instantaneous shutdown of the tail engine or with the cessation of the tail engine and the instantaneous disconnection of the nasal engine.

Figure 8b depicts a fragment of a safe emergency landing of a quadcopter with a failure of the right engine and the instant disconnection of the left

engine or the failure of the left engine and instant disabling of the right engine.

IV. DISCUSSION OF THE SIMULATION RESULTS OF THE LANDING PROCESS OF AN EMERGENCY QUADROPTER

When free fall all four engines are off, the quadcopter reaches the ground in just 6 seconds.

The vertical component of the landing speed at the same time is 16.5 m/s. In case of refusal of one engine and working three remaining during the time of reduction, there are moments of forces concerning the axes of pitch, roll and yaw. Due to this, the rate of change does not change monotonously, but the vertical component of the landing speed decreases to 14 m/s [6].

In the event of a faulty nasal or tail motor, the quadcopter falls to the landing site with screws down (pitch = 180°) and with a roll of 40° and -33°, respectively. Nonzero values of the horizontal velocity component at the moment of landing are an additional danger $V_x = 1.47$ m/s and $V_y = -1.44$ m/s, respectively. Depending on the friction coefficient at the landing site, the quadcopter will still travel some distance along the ground.

In the event of a faulty right or left motor, the quadcopter falls to the landing site with screws down (roll = 180°) and with a pitch of -47° and 28°, respectively. Nonzero values of the horizontal velocity component at the moment of landing are an additional danger $V_x = -1.05$ m/s, $V_y = 0.59$ m/s and $V_x = 1.1$ m/s, $V_y = -0.6$ m/s, respectively. Depending on the friction coefficient at the landing site, the quadcopter will still travel some distance along the ground.

If simultaneously with the engine that is out of order, turn off the power of the electric motor, which is located at the opposite end of the same traverse as the defective electric motor, then the time of fall is 11.7 s, and the vertical landing speed is 5.6 m/s. The horizontal components of the speed all the time will be zero, that is, the quadcopter will fall vertically down. The roll and pitch during the fall are zero, that is, the quadcopter will always land on the chassis. Due to the fact that in this case, not compensated moments of the forces of two opposite engines, the speed of rotation around the vertical axis at the time of landing will be 4.4 rad/s. This speed will create a distance of 22.5 cm from the center of mass of the acceleration 4.4 m/s^2 .

V. CONCLUSION

The results of the conducted research determine the effectiveness and practical significance of the use of the proposed methods of safe landing of the quadcopter, which in the flight unexpectedly refused one of the four pairs of propeller. To reduce the vertical component of the landing speed when the failure of one of the engines it is expedient as soon as possible to disconnect the voltage from the opposite engine, which is located on the opposite end of the console. In this case, the horizontal components of the speed are practically zero.

REFERENCES

- [1] H. Huang, G. M. Hoffmann, S. L. Waslander, and C. J. Tomlin, "Aerodynamics and control of autonomous quadrotor helicopters in aggressive maneuvering," *IEEE International Conference on Robotics and Automation*, May 2009, pp. 3277–3282.
- [2] David Wissiere, Piere-Jean Bristeau, Alain Piere Martin, and Nikolas Petit, "Experimental autonomous flight of a small-scaled helicopter using accurate dynamics model and low-cost sensors," *Proceeding of the 17th World Congress The International Federation of Automatic Control*, Seoul Korea, July 6-11, 2008, pp. 14642–14650.
- [3] Philip Nartin and Erwan Salaun, "The True Role of Accelerometer Feedback in Quadrotor Control," *IEEE International Conference on Robotics and Automation*, Anchorage, May 2010, pp.1623–1629.
- [4] B. Marcelo, R. C. B.Sampaio, S. Bounabdallah, V. de Perrot, and R. Siegwart, "In-Flight Collision Avoidance Controller Based Only on OS4 Embedded Sensors," *Journal of the Brazilian Society of Mechanical Sciences and Engineering*. vol. 34, no. 3, Rio de Janeiro July/Sept. 2012 – March 2012, vol. XXXIV, no. 3, July-September 2012, pp. 294–107.
- [5] B. Blagitko and Y. Mochulsky, "Mathematical modeling of quadcopter stabilization in flight," *Electronics and Information Technologies*, vol. 3, pp. 96–107, 2013.
- [6] Y. Mochulsky. Matlab in physical research: tutor. – method. manual. Lviv: VTS LNU them. Ivan Franko, 2004, pp. 3–121.

Received June 06, 2018.

Blagitko Bohdan. Candidate of Science (Engineering). Associate Professor.

Department of Radiophysics and Computer Technologies of Lviv Ivan Franko National University, Lviv, Ukraine.

Education: Lviv Politechnical Institut, Lviv, Ukraine, (1963).

Research area: microprocessor technology and microprocessor systems, automatic control systems, robotics, programming of software and hardware complexes, programming languages – C, C#, Python.

Publications: 190.

E-mail: blagitko@gmail.com

Mochulsky Yuriy. Candidate of Science (Engineering). Associate Professor.

Department of Radiophysics and Computer Technologies: of Lviv Ivan Franko National University, Lviv, Ukraine

Education: Lviv Politechnical Institut. Lviv, Ukraine, (1964).

Research area: digital signals and systems, automatic control systems, robotics, simulation of complex dynamic systems, programming languages C#, Matlab.

Publications: 87.

E-mail: mochulsky@ukr.net

Б. Я. Благітко, Ю. С. Мочульський. Забезпечення безпечного приземлення квадрокоптера у разі аварії

За допомогою математичного моделювання визначені основні особливості аварійного приземлення квадрокоптера. Наведено результати симуляції процесу приземлення квадрокоптера в разі виходу з ладу однієї з чотирьох пар електродвигун-гвинт. Запропоновано методи безпечного приземлення безпілотного квадрокоптера у разі відмови однієї з чотирьох пар електродвигун-гвинт. В основі запропонованих методів лежить використання ефекту парашутування. Парашутування досягається шляхом миттєвого примусового відключення живлення двигуна, який знаходиться на протилежному кінці тої ж траверси, що і несправний двигун. У результаті вертикальна швидкість квадрокоптера в момент приземлення значно зменшується в порівнянні зі швидкістю вільного падіння.

Ключові слова: квадрокоптер; висотомір; трьохосовий гіроскоп; трьохосовий акселерометр; трьохосовий магнітометр; контроль.

Благітко Богдан Ярославович. Кандидат технічних наук. Доцент.

Кафедра радіофізики та комп'ютерних технологій, Львівський національний університет імені Івана Франка, Львів, Україна.

Освіта: Львівський політехнічний інститут, Львів, Україна, (1963).

Напрямок наукової діяльності: мікропроцесорна техніка та мікропроцесорні системи, системи автоматичного керування, робототехніка, програмування програмно-апаратних комплексів, мови програмування – C, C#, Python.

Кількість публікацій: 190.

E-mail: blagitko@gmail.com

Мочульський Юрій Степанович. Кандидат технічних наук. Доцент.

Кафедра радіофізики та комп'ютерних технологій, Львівський національний університет імені Івана Франка, Львів, Україна.

Освіта: Львівський політехнічний інститут, Львів, Україна, (1964).

Напрямок наукової діяльності: цифрові сигнали та системи, системи автоматичного керування, робототехніка, моделювання складних динамічних систем, мови програмування C#, Matlab.

Кількість публікацій: 87.

E-mail: mochulsky@ukr.net

Б. Я. Благітко, Ю. С. Мочульський. Обеспечение безопасной посадки квадрокоптера при аварии

С помощью математического моделирования определены основные особенности аварийной посадки квадрокоптера. Приводятся результаты моделирования посадки квадрокоптера в случае отказа одной из четырех пар электродвигатель-винт. Предложены методы безопасной посадки беспилотного квадрокоптера в случае отказа одной из четырех пар электродвигатель-винт. Основой предлагаемых методов является использование эффекта парашютирования. Парашютирование достигается за счет выключения питания электродвигателя, который расположен на противоположном конце той же траверсы, что и неисправный электродвигатель. В результате вертикальная скорость квадрокоптера во время посадки значительно уменьшается по сравнению со скоростью свободного падения.

Ключевые слова: квадрокоптер; высотомер; трехосный гироскоп; трехосный акселерометр; трехосный магнитометр; контроль.

Благітко Богдан Ярославович. Кандидат технических наук. Доцент.

Кафедра радиофизики и компьютерных технологий, Львовский национальный университет им. Ивана Франко, Львов, Украина.

Образование: Львовский политехнический институт, Львов, Украина, (1963).

Направление научной деятельности: микропроцессорная техника и микропроцессорные системы, системы автоматического управления, робототехника, программирование программно-аппаратных комплексов, языки программирования – C, C#, Python.

Количество публикаций: 190.

E-mail: blagitko@gmail.com

Мочульський Юрій Степанович. Кандидат технических наук. Доцент.

Кафедра радиофизики и компьютерных технологий, Львовский национальный университет им. Ивана Франко, Львов, Украина.

Образование: Львовский политехнический институт, Львов, Украина, (1964).

Направление научной деятельности: цифровые сигналы и системы, системы автоматического управления, робототехника, моделирование сложных динамических систем, языки программирования C#, Matlab.

Количество публикаций: 87.

E-mail: mochulsky@ukr.net